



PROJEKCI BILTEN 2012



OPŠTI KATALOG SVIH ELEMENATA

ROŠTILJI



KAMINI KOJI GREJU































MAŠINE I OPREMA

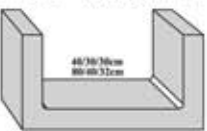





























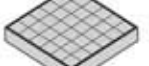



















-VIBRO OPREMA
-ADITIVI I BOJE
ZA BETON
-EKOLOŠKI PIGMENTI

-NA ZAHTEV KUPACA, ELEMENTI MOGU
BITI BOJENI OXSIDNIM BOJAMA ZA
BETON (BRAYER, REAR) I U
CRVENOJ, ŽUTOJ, ZELENIJ, PLAVIJOJ BOJI,
KAO I POSREDMIM EKOLOŠKIM
PIGMENTIMA U BRAN, CRVENOJ I ŽUTOJ
BOJI. POSTOJE NEKI ČIŠĆIVAČI I
ADITIVI ZA SPECIFIČNE ZAHTEVE I
POSREDMIM USLOVE KAO ŠTO SU
HILABOČE, REČNI I PLAVINSKI
PREVLJE, ZNATNO PRODUŽAVA MESTA
KOJA JAČE MORAJU BITI ODPORNA NA
BARANJE, SOLE I NAFTU.
-CVETANJE, RAZLIČKE I BOJE KOD
BETONSKE BOJE PROJEKTOVANJE
SE NE MOGU IZBEĆI I ZBOG TOGA NISU
RAZLOG ZA REKLAMACIJU.
-CVETANJE NE NARUŠAVA MEHANIČKA
SNAGIJA BETONA, SA PRIRODNO
UTICAJEM VREMENA I POD NORMALNIM
OKOLNOSTIMA CVETANJE SE SMANJUJE,
A BELILO KOD BETONSKE PROJEKTOVANJA
TOKOM VREMENA NESTAJE.

PRESOVANI PROGRAM

BEHATON  16,4/20/6-8cm POTROŠNJA-31 kom/m ²	OLIMPIJA  16,5/24,5/6cm POTROŠNJA-40 kom/m ²	REKET  22/13/6cm POTROŠNJA-39 kom/m ²	DELTOID  29/17/6 cm POTROŠNJA-41 kom/m ²	LEPEZA  21,5/16/6-8cm POTROŠNJA-41 kom/m ²	BAROK+  22/26/6-8cm POTROŠNJA-28 kom/m ²	MEBA  60/40/16cm POTROŠNJA-6kom/m ²
RUSTIK  28/21/6 21/14/6 14/14/6 7/14/6	CIGLA  18,5/21cm POTROŠNJA-45 kom/m ²	SAČE  MALO-18,5/16cm POTROŠNJA-44 kom/m ²	SAČE  VELIKO-23,5/20,5cm POTROŠNJA-27 kom/m ²	VENECIJA  20/20/5-8cm POTROŠNJA-25 kom/m ²	TRAPEZ  34/15/6-8cm POTROŠNJA-26 kom/m ²	PLOČE  40/40/6-8cm 30/30/6-8cm 15/15/6-8cm 18/18/6-8cm
PLETENICA  30/30/40 30/30/28	LEŽAJI  40/40/6-8cm 30/30/6-8cm	BLOK ZA UREĐENJE OBALA  16,4/20/6-8cm 30/30/6-8cm	KANALETE  40/40/10cm 40/40/15cm 45/30/10cm 60/40/10cm	BETONSKI ELEMENTI ZA ŽARDINJERE  40/40/30/30cm 40/20/30/30cm 40/30/30/30cm 15/30/30/30cm	PETROVARADIN  18,5/21 cm POTROŠNJA-43 kom/m ²	IVIČNJACI  40/30/30cm 60/40/32cm
ŠVEDSKI SLOG IMITACIJA KAMENA ZA POPLOČAVANJE 	VELIKI BEHATON  40/32/10 cm	KORUBA  51/48/20cm	IVIČNJACI  18/12/30-40/8cm 20/24/40cm 8/20/50cm	PLOČA  50/50/6 cm	IVIČNJACI  18/18/40cm 7/20/40cm	IVIČNJACI  18/12/30-40/8cm 20/24/40cm 8/20/50cm

LIVENI PROGRAM

BEHATON  16,4/20/6-8cm POTROŠNJA-31 kom/m ²	HRAPAVA KOST  22/13,5/2,5-4-4cm	SAČE  18,5/16/2,5-4-4cm POTROŠNJA-41 kom/m ²	SAČE III-a  18/18/2,5-4-4cm	LEPEZA  24/17 d 64/2,5 cm POTROŠNJA-32 kom/m ²	BAROK  22/26/6-8cm POTROŠNJA-28 kom/m ²	MOZAIK  d=64/2,5 cm POTROŠNJA-33 kom/m ²	RASTER  20/20 d=64/2,5 cm POTROŠNJA-14,5 kom/m ²
HRAPAVA CIGLA  18/20/2,5-4-4cm POTROŠNJA-50 kom/m ²	KANALETE  25/35/8 16/25/6	KRUG NIŠ 	DASKA  43/14/3 cm	LIVENA REŠETKA  armirana-60 ili 610 45/38/6	PLOČA  30/30 POTROŠNJA-4 kom/m ²	OKAPNICA ZA STUBOVE  40/40/3-5cm	BAZENSKA OBLOGA  36-40/33/2,5-5 cm 40/33/5,5 cm UGONI I ŽARDINJSKI IVIČNJACI
BUNJA  25/25 d=2,5 cm POTROŠNJA-16 kom/m ²	PLOČA  25/25 d=6 cm POTROŠNJA-16 kom/m ²	GAZIŠTE  30/20 d=4,5 cm POTROŠNJA-11 kom/m ²	ČELO  30/30 d=4,5 cm POTROŠNJA-11 kom/m ²	ČELO  40/40 d=5 cm POTROŠNJA-6 kom/m ²	ČELO  40/40/3-5cm	BAZENSKA OBLOGA  36-40/33/2,5-5 cm 40/33/5,5 cm UGONI I ŽARDINJSKI IVIČNJACI	
UZDUŽNA KAPA  27/39 35/39	ČELO I GAZIŠTE  GAZIŠTE-125/3/5 ČELO-125/1/3 35/27/2cm	GAZIŠTE  30/25/3cm	ČELO  25/17/3cm	ČELO  35/17/3cm	BAZENSKA OBLOGA  36-40/33/2,5-5 cm 40/33/5,5 cm UGONI I ŽARDINJSKI IVIČNJACI		
IVIČNJACI  12/18/40cm 12/18/30cm	IVIČNJACI  18/24/50cm 18/24/30cm	IVIČNJACI  10/24/30cm 10/24/50cm	IVIČNJACI  5/13/50cm	IVIČNJACI  8/16/50cm	IVIČNJACI  8/16/25cm	IVIČNJACI  18/30/40cm	
IVIČNJACI  7/21/50cm	IVIČNJACI  10/25/50cm	IVIČNJACI  8/21/50cm	IVIČNJACI  18/30/50cm	IVIČNJACI  15/28/50cm	RADIJALNI IVIČNJACI  16/12/30cm 16/11/40cm	ARMIRANI POKLOPAČ  50/50/10cm	
IVIČNJACI  50/50/10 cm	KANALETA  180/100/65 cm	KANALETA  70/100/65 cm	REŠETKA  178/66/15 cm	DRŽAČ ZA SUNCOBRAN  Ø 70			

BLOKOVI I GUMA ROBA

BETONSKI BLOK

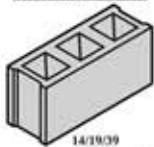

14/19/39

BETONSKI BLOK

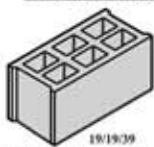

19/19/39

BETONSKI BLOK

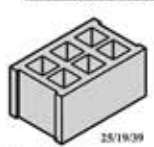

25/19/39

BETONSKI BLOK



18/19/39

DIMNJAČKI VENTILACIONI BLOKOVI

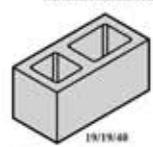

19/19/40

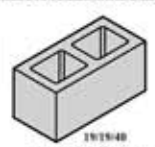

19/19/40

DIMNJAČKI VENTILACIONI BLOKOVI



blok H-3
25/19/41

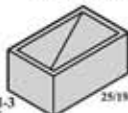

25/19/41

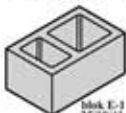

blok E-1
25/19/41

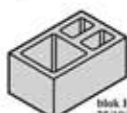

blok H-2
25/19/41

BETONSKA ISPUNA PLAŠT DIMNJAKA DEZEZA



35/16/18



29/29/32



56,5/45/20cm



50/41/20cm

DIMNJAČKA KAPA I VRAT

ŠTUCNA VRATANCA ZA DIMNJAK



REŠETKA ZA STAJE
ZA SYVINJE I GOVEĐA



STEPENIK



BALUSTERI



TEMELJ
ZA PLASTENIKE
I RAZNE
MONTAŽNE OBJEKTE



12/12/100

KUGLA SA VRATOM



44,3

KRST



40/30/7

TERAČO KRST ZA TRGOVE
(4,5/1,5m)(25/25cm)

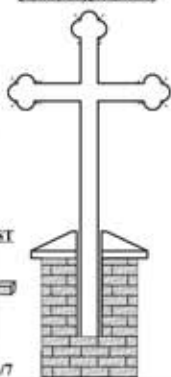

ŽARDINJERE

SANĐUČASTA



50/50/50

OKRUGLA



90/70

KUPASTA



50/50

Učvršćivač



42/31/8/9

SANĐUČASTA



100/45/33

SANOGICAMA



100/15/55

PEHARASTA



75/23/46

KOSUSNA



107,5/55/45

ŽARDINJERA
ZA FOTOFONI ŽID



30/30/13

Obrnuta



43/39

PROGRAM ZA OGRADE

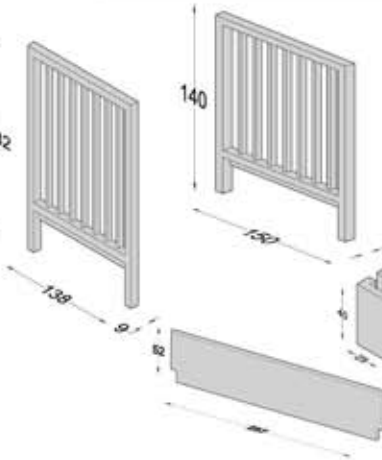

BLOK BUNJA
ZA OGRADE



39/20/14

BLOK BUNJA
ZA OGRADE



48/19/17

BLOK BUNJA
ZA OGRADE



40/10/10

ELEMENTI BETON-GUMA



PLOČE BETON-GUMA
50/50 d=4-3 cm



IVIČNIK BETON-GUMA
50/18/10

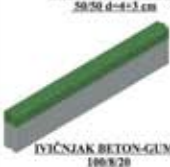

IVIČNIK BETON-GUMA
100/8/20

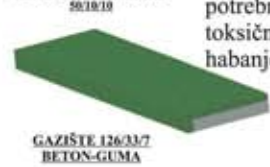

GAZIŠTE 126/30/7
BETON-GUMA



BAZISNI ELEMENT
BETON-GUMA

Elementi beton-guma namenjeni za privatne objekte, dečija igrališta, vrtiće, sportske terene, bolnice... Prednosti beton guma obloga: elastične sa potrebnom čvrstoćom, nisu toksične, otporne na habanje, ne klize,

PARKOVSKI PROGRAM



KLUPA SA NASLONOM



NOGE ZA KLUPU
SA NASLONOM
104/72/7,5 cm



KORPA
ZA SMEĆE



BETONSKA
KORPA
ZA SMEĆE



STALAK ZA
SUNCORBAN



ŽARDINJERA



KLUPA BEZ NASLONA



NOGE ZA KLUPU
BEZ NASLONA
40/60/5 cm



GAJGER
SLIVNIK



ZAŠTITNI STUBIĆI



Dvočetna



Trčetna
KUGLE ZA
PARKIRALIŠTA
(kugle i glatke)



ČESMA



Pogon I
NOVI SAD
(SREMSKA KAMENICA)
Sonje Marinković 2a
Telefon: +381 21 464 174
Fax: +381 21 462 255
Mobilni: +381 62 6000 64



PROIZVODNJA
BETONSKE GALANTERIJE
I TRGOVINA
GRAĐEVINSKOM OPREMOM
www.tiha-beton.rs
office@tiha-beton.rs

Pogon II
BEOGRAD
(PEČINCI)
Školska 53

Fax: +381 21 462 255
Mobilni: +381 62 6000 64



UPUTSTVO ZA POSTAVLJANJE PLOČNIKA



Iskop mora biti 30-50 cm širi od predviđene površine koja se želi popločati. Nosivi sloj za ugradnju pločnika treba biti debljine 20-35 cm, a sastoji se od prirodnog ili drobljenog šljunka fi 0-32mm, koji se ugrađuje po slojevima sa odgovarajućom mehanizacijom. Zbijanje materijala se vrši vibracijskim valjkom do projektiranog modula zbijenosti. Radi odvodnje, nosivi sloj mora imati nagib u tačnosti od 1 cm. Površina nosivog, dobro zbijenog sloja uvek je niža od gotove površine popločavanja plus 2-4 cm. Kod rigola, slivnika, poklopaca i dr. priključaka prema drugim građevinama moraju se predvideti vremenska sleganja gotove površine. Gotove površine su pre vibriranja 2-5 mm iznad rubova takvih gotovih elemenata. Kada se površina dobro pripremi, na dobro zbijenu površinu nanosi se sloj drobljenog peska, granular 4-8 mm. Pesak ili tucanik se razvlače aluminijumskom letvom ravnomerno po površini. Takvom površinom se ne sme hodati. Na nju se polažu elementi za popločavanje 2-8 cm debljine po kojima se sme hodati. Nakon postavljanja elemenata za popločavanje prilazimo čišćenju površine, koja se nabija ili ravna vibro pločom koja je ispod obložena gumenom površinom. Nakon toga se popločana površina ispunjava isključivo suvim peskom. Postupak treba ponoviti više puta da popločana površina dobije lep i prirodan izgled. Najnovija iskustva pokazuju da fugne ne treba zapunjavati. Eventualne razlike u nijansi boja kod pojedinih elemenata za popločavanje tehnički su uslovljene tj. elementi su proizvedeni u različitim vremenskim razmacima, pri različitim temperaturama, pri različitoj vlažnosti, a mogu biti i u boji cementa isl. Prema iskustvu, razlike u boji tokom vremena nestaju i sve se ujednačava usled korišćenja i vremenskih uticaja. Razlike u nijansama boja kod elemenata od sivog cementa, takodje mogu nastati zbog samog cementa jer proizvođači ove sirovine ne mogu da garantuju boju cementa. Kod betonskih elemenata moguća je pojava tzv "cvetanja" betona, naročito u zimsko-prolećnom periodu, koja vremenom nestaje i ne smatra se nekvalitetom. Ovu pojavu je moguće ublažiti dodavanjem aditiva u sam beton, kao i posebnom negom betona, što je potrebno naglasiti prilikom samog ugovaranja.

Za svaku porudžbinu proizvoda, potrebno je pojedinačno ugovaranje. Proizvođač zadržava pravo izmene cenovnika, isti je orijentacioni. Izveštaji o kvalitetu proizvoda se rade na zahtev kupca, a kontrola kvaliteta je konstantna.

TON KARTA OSNOVNIH BOJA BETONSKIH ELEMENATA*

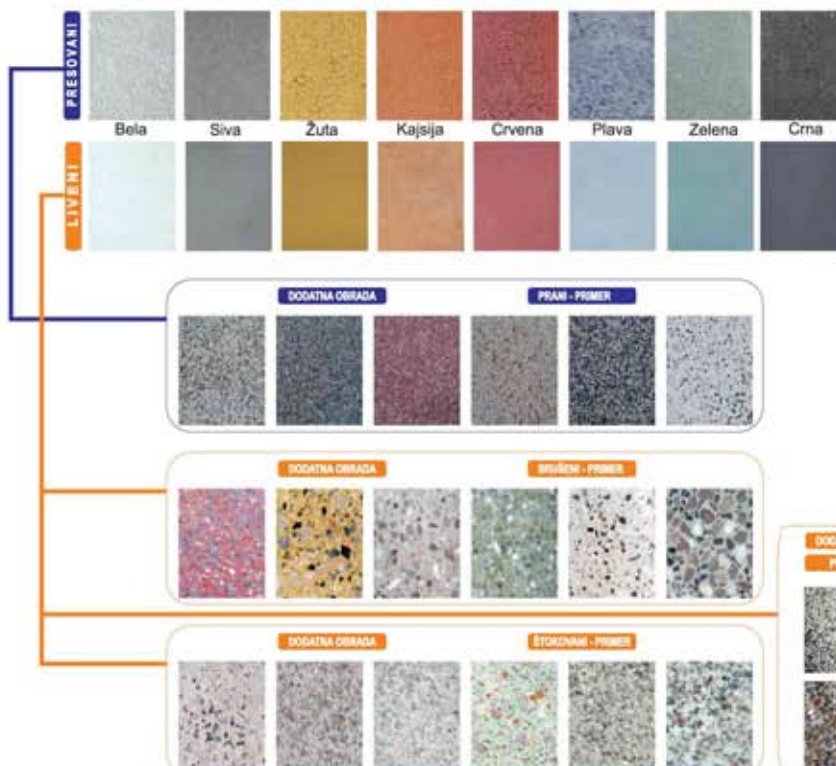

*Boje u katalogu su približne i služe za prezentaciju. Kupac se mora lično upoznati sa proizvodom. Ne preporučuje se kupovina preko kataloga.

NAZNAČENE MARKICE O KVALITETU PROIZVODA OMOGUĆAVAJU KUPCU DA SAM IZABERE KVALITET PROIZVODA

-  GARANCIJA
-  ČVRSTOĆA
-  UPLIJANJE VODE
-  MRAZ - SO
-  ELEMENTI OD SIVOG CEMENTA
-  ELEMENTI OD BELOG CEMENTA
-  PRESOVANI ELEMENTI (jednoslojni/dvoslojni)
-  LIVENI ELEMENTI (jednoslojni/dvoslojni)
-  ELEMENTI SA KVARCOM
-  ELEMENTI SA GRANITOM
-  ELEMENTI SA MERMEROM
-  BRUŠENI ELEMENTI
-  PESKARENI ELEMENTI
-  ŠTOKOVANI ELEMENTI
-  PRANI ELEMENTI
-  RUSTIK ELEMENTI (rustik rubovi)
-  ELEMENTI SA SMANJENIM PRIJANJANJEM ŽVAKAČIH GUMA
-  ELEMENTI SA ZAŠTITNIM PREMAZIMA
-  B-G ELEMENTI (BETON-GUMA) d=2.5-8cm
-  PROTIVKLIZNI
-  OTPORNO NA NAFTNE DERIVATE
-  JEDNAKE POVRŠINE





**IZVOĐENJE
GRAĐEVINSKIH
RADOVA**





Presovani betonski elementi se proizvode tako što pripremljena betonska smesa odlazi u hidrauličnu presu, koja uz pomoć visokog pritiska od 100-250 bara i vibracije, nabija beton u jednom ili dva sloja - donji grublji i gornji finiji.

U zavisnosti koliko slojeva ima, elemente delimo na:

- jednoslojne
- dvoslojne

Beton za presovane elemente se pravi od višefrakcijskog separisanog agregata, cementa visoke marke i aditiva. Beton finijeg tzv. završnog sloja sadrži kvarcni pesak, mleveni granit, pigment.

Završni sloj može da se ispira vodom, i tako dobijamo *prane* elemente, koji se proizvode od mlevenog prirodnog kamena.

Proizvedeni elementi odležavaju dok ne postignu određenu čvrstoću. Tokom odležavanja, provodi se potrebna nega betona.

Standardna otpornost: MB30, do 50 ciklusa na dejstvo mraza i soli

Otpornost po posebnoj zahtevu: MB40, do 100 ciklusa na dejstvo mraza i soli

Više informacija www.tiha-beton.rs

SADRŽAJ:

DELTOID	7
BEHATON	8
REKET	9
LEPEZA	16
PLOČE 10x10,10x20,20x20,20x30,30x30	10-11
RUSTIK	12-13
PETROVARADIN CIGLA	14
MEBA RASTER	15
PRESOVANI IVIČNJACI	28
PRESOVANE KANALETE	30

Primeri slogova:

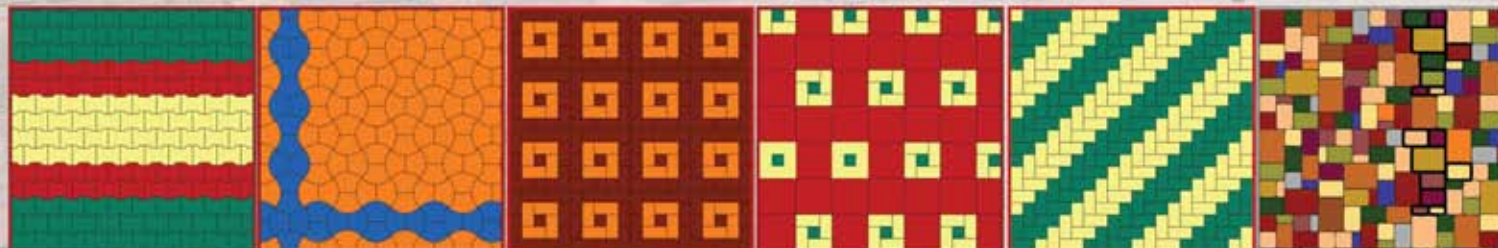

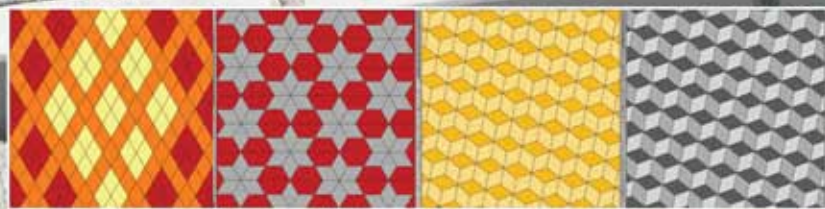

DELTOID

Potrošnja

42 kom/m²

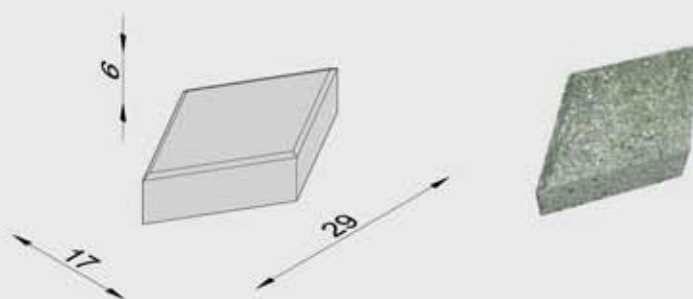



BEHATON

PRESOVANI PROGRAM

8

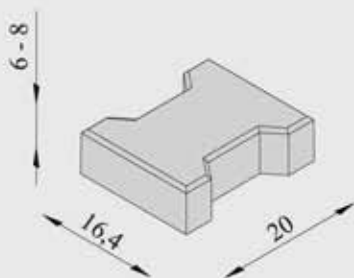

Potrošnja

35 kom/m²





REKET

Potrošnja

38 kom/m²

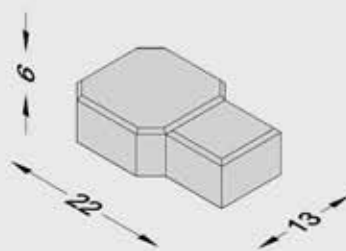



10x10, 10x20, 20x20, 20x30, 30x30

PLOČE

PRESOVANI PROGRAM

10x10 - 100 kom/m²

10x20 - 50 kom/m²

20x20 - 25 kom/m²

20x30 - 16.5 kom/m²

30x30 - 11 kom/m²

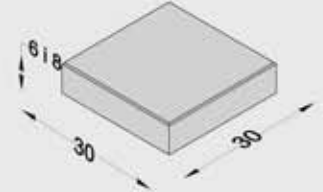
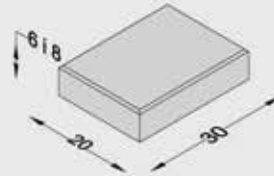
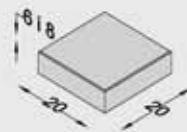
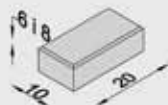
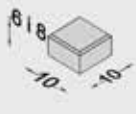





RUSTIK

PRESOVANI PROGRAM

12

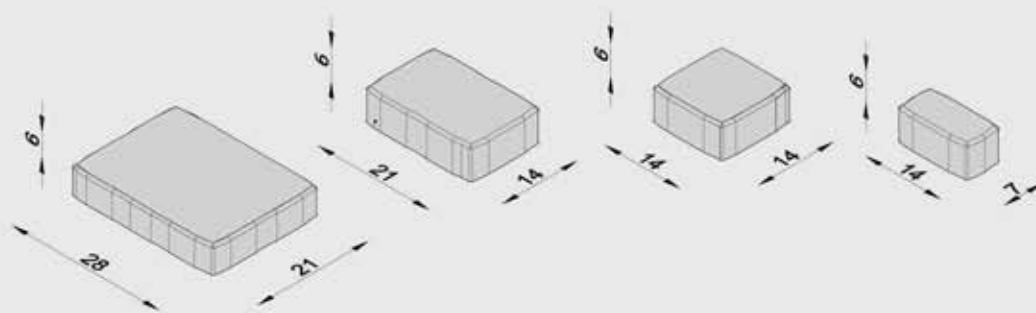





PETROVARADIN CIGLA

PRESOVANI PROGRAM

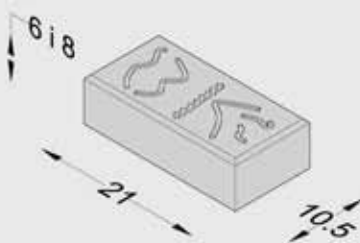

Potrošnja

43 kom/m²



MEBA RASTER

Potrošnja

4 kom/m²

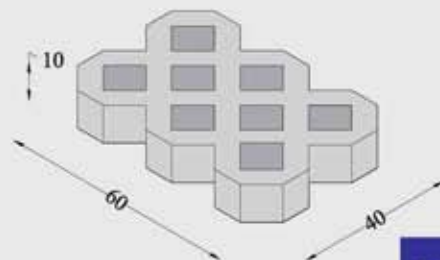



LEPEZA

PRESOVANI PROGRAM

16

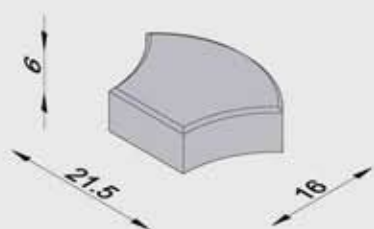

Potrošnja

41 kom/m²





Liveni betonski elementi se proizvode u plastičnim ili metalnim kalupima. Svež beton se sipa u kalupe, oblika proizvoda koji se vibriraju na vibro stolu.

Beton za livene elemente se pravi od višefrakcijskog separisanog agregata, cementa visoke marke, aditiva. Za elemente u boji, u beton se sipaju pigmenti.

Beton u kalupima odlažemo na mesto za odležavanje i negu betona, dok ne postigne potrebnu čvrstoću. Betonski elementi se neguju bar 5 dana u odgovarajućim uslovima. Nakon toga, iz kalupa izvađeni betonski elementi se ređaju na palete, gde stoje još nekoliko dana do ugradnje.

Standardna otpornost: MB30, do 50 ciklusa na dejstvo mraza i soli

Otpornost po posebnom zahtevu: MB40, do 100 ciklusa na dejstvo mraza i soli

Više informacija www.tiha-beton.rs

SADRŽAJ:

SACE I	18
BAROK	19
HRAPAVA CIGLA	20
HRAPAVA I GLATKA KOST	21
ČELA I GAZIŠTA	22
BAZENSKI ELEMENTI	23
ČOKOLADA	24
PLOČA 50/50/5	25
PLOČA 50/50/10	26
SACE III	27
LIVENI IVIČNJACI	29
LIVENE KANALETE	31

LIVENI PROGRAM

Primeri slogova:





SACE 1

LIVENI PROGRAM

18

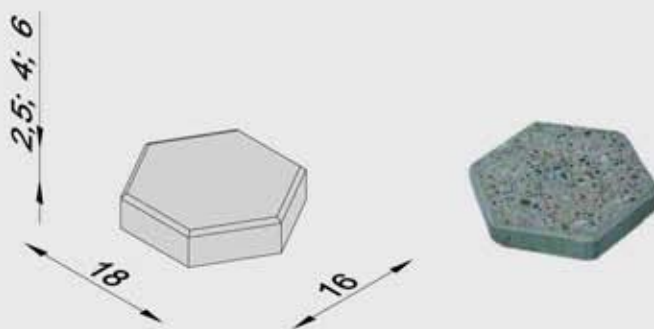

Potrošnja

42 kom/m²





BAROK

Potrošnja

28 kom/m²

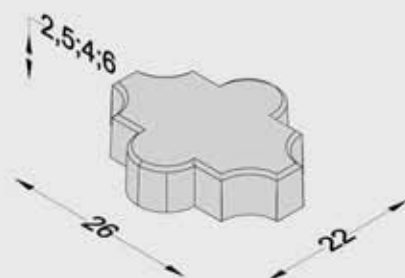

STVENI PROGRAM



HRAPAVA CIGLA

LIVNI PROGRAM

20

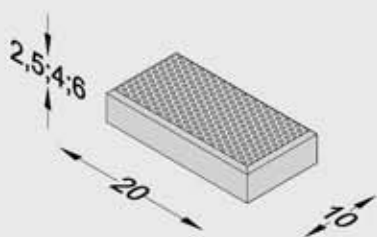

Potrošnja

50 kom/m²





HRAPAVA I GLATKA KOST

Potrošnja

41 kom/m²



LIVNI PROGRAM



ČELA I GAZIŠTA

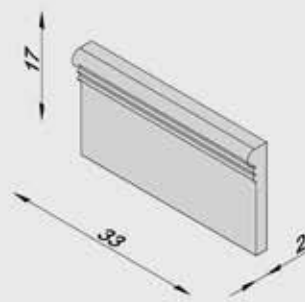
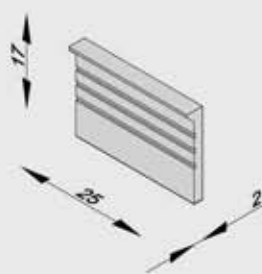
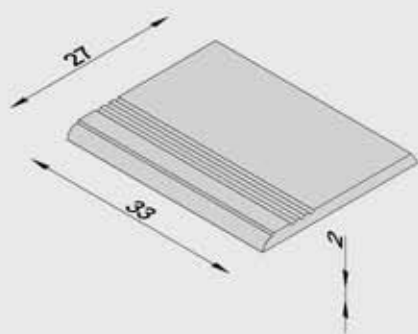



2.19.12

BAZENSKI ELEMENTI

Konusni

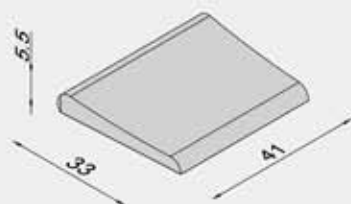

Ravni

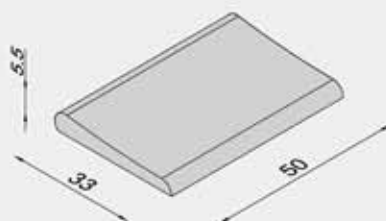

Ugaoni

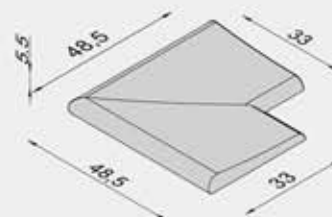



COKOLADA

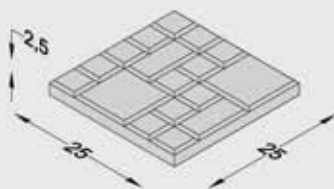

Potrošnja

16 kom/m²



PLOČE 50/50/5

Potrošnja

4 kom/m²

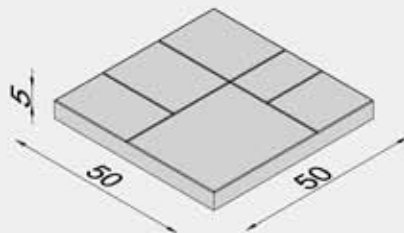

25

STVENI PROGRAM



PLOČE 50/50/10

LIVNI PROGRAM

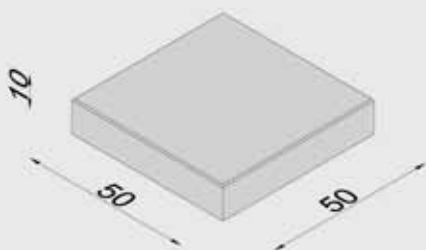

Potrošnja

4 kom/m²

26





SACE III

Potrošnja

44 kom/m²

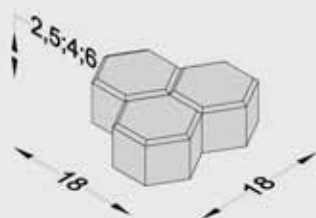



IVICNJACI

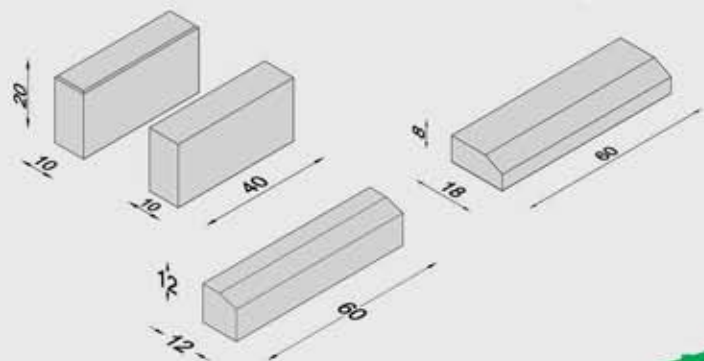
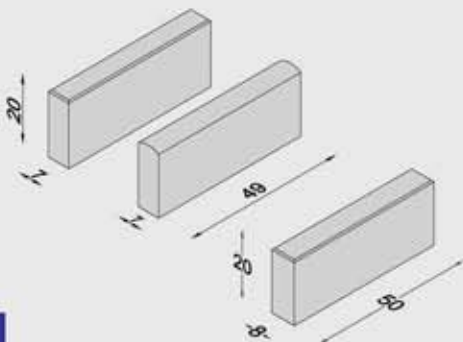



IVICNJACI

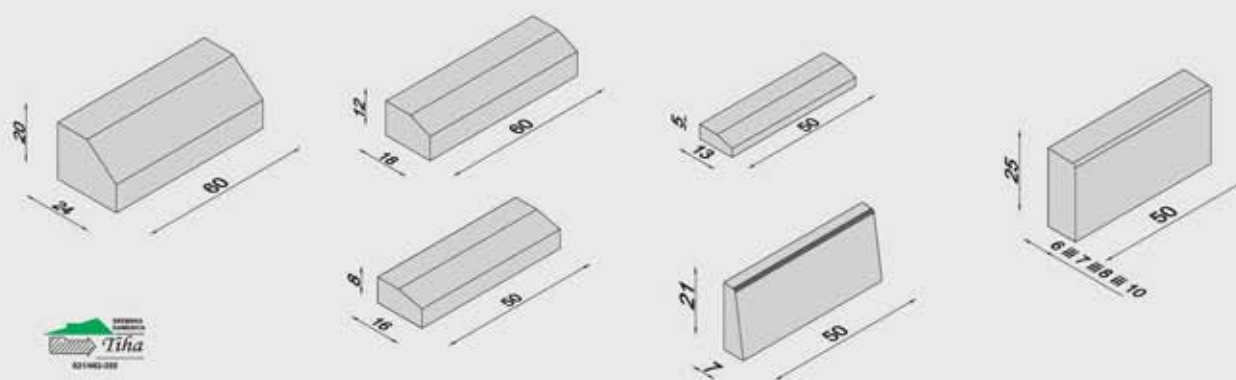



KANALCETE

PRESOVANI PROGRAM

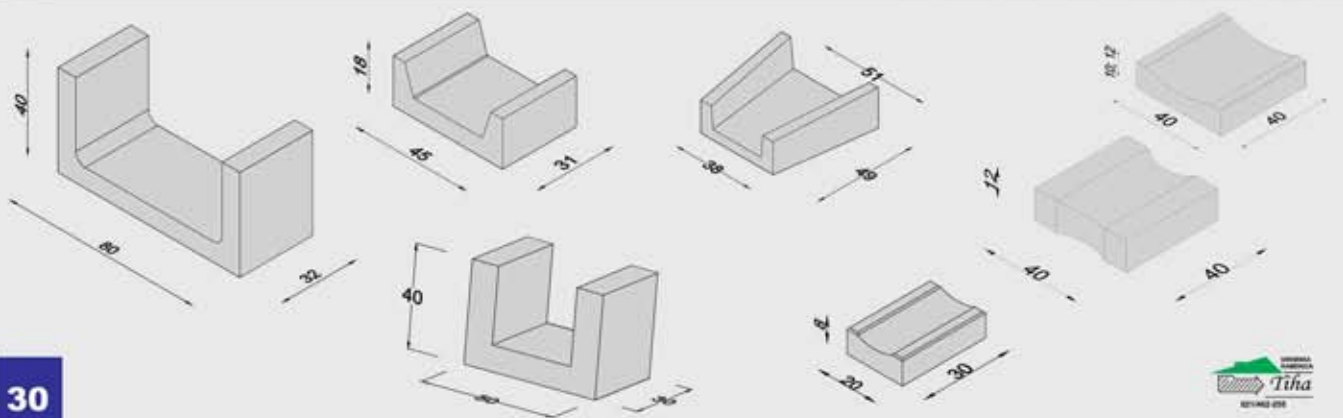



Kanalete za teški saobraćaj



KANALETE

Potrošnja

25/16/6 - 4 kom/m¹

35/25/8 - 3 kom/m¹

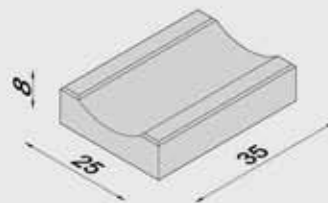
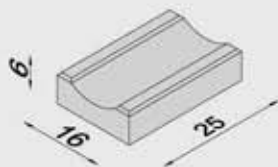



SADRŽAJ:

ŽARDINJERE	33
POTPORNE ŽARDINJERE	34
KUGLE, STUBIĆI	35
KLUPE, ČESME, KANTE...	36
ELEMENTI ZA OGRADE	37
BETON-GUMA	38



PARKOVSKI PROGRAM

PARKOVSKI PROGRAM



Elementi za javne površine, bašte....

Više informacija na www.tiha-beton.rs





ŽARDINJERE

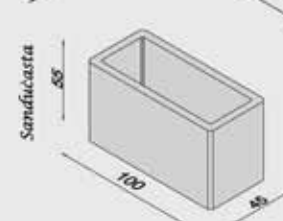
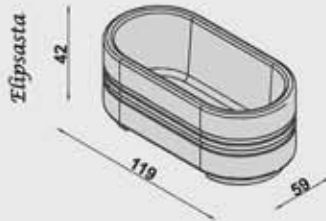
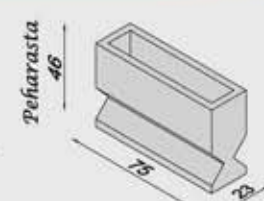
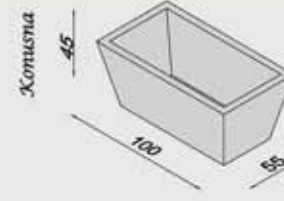
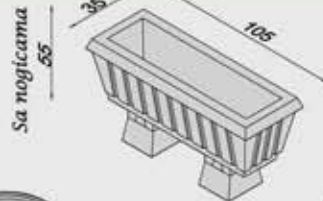
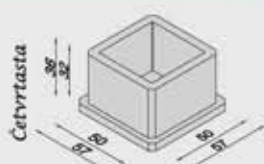



POTPORNE ŽARDINJERE

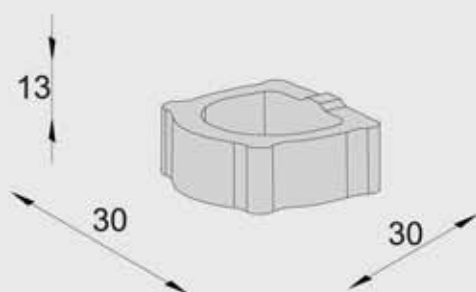



ZAŠTITNE KUGLE I STUBIČI

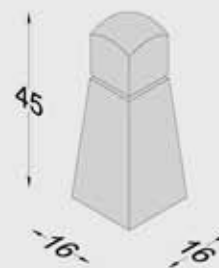
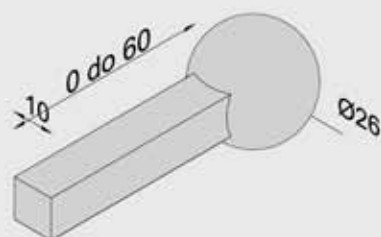
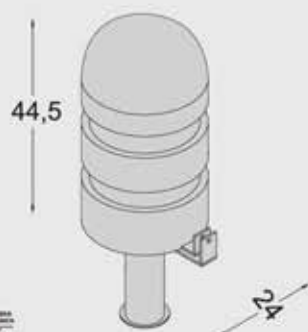



KLUPE, ČESME, KANTE...



NOGE ZA KLUPE
SA NASLONOM
104/72,5 cm



NOGE ZA KLUPE
BEZ NASLONA
40/60,5 cm



KLUPA SA NASLONOM



KLUPA BEZ NASLONA



KORPA
ZASMEČE



GAJER
SLAVNIK



STAKAR ZA BICIKLE



BETONSKA
KORPA
ZA SMEČE



ČESMA



BETONSKI ELEMENTI ZA OGRADE

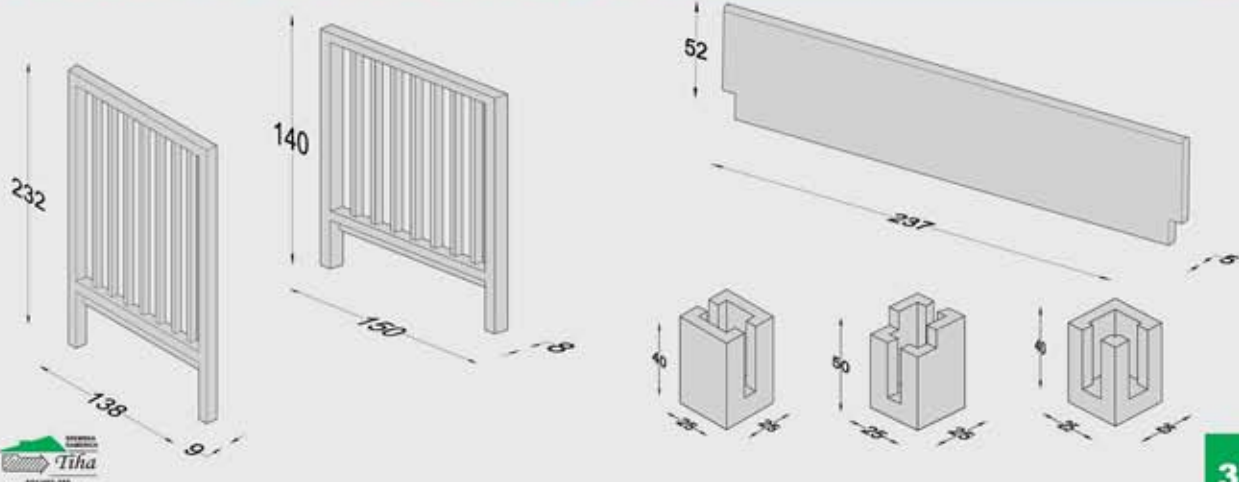



ELEMENTI BETON-GUMA

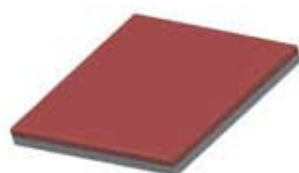

PLOČE BETON-GUMA
50/50 d=4+3 cm



IVIČNJAK BETON-GUMA
50/10/10



IVIČNJAK BETON-GUMA
100/8/20



GAZIŠTE 126/33/7
BETON-GUMA

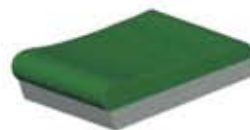

BAZENSKI ELEMENT
BETON-GUMA

Elementi beton-guma namenjeni za privatne objekte, dečija igrališta, vrtiće, sportske terene, bolnice... Prednosti beton guma obloga: elastične sa potrebnom čvrstoćom, nisu toksične, otporne na habanje, ne klize, vodootporne, dugovečne, smanjuju opasnost od povreda i ozleda pri padu...



ŠVEDSKI SLOG

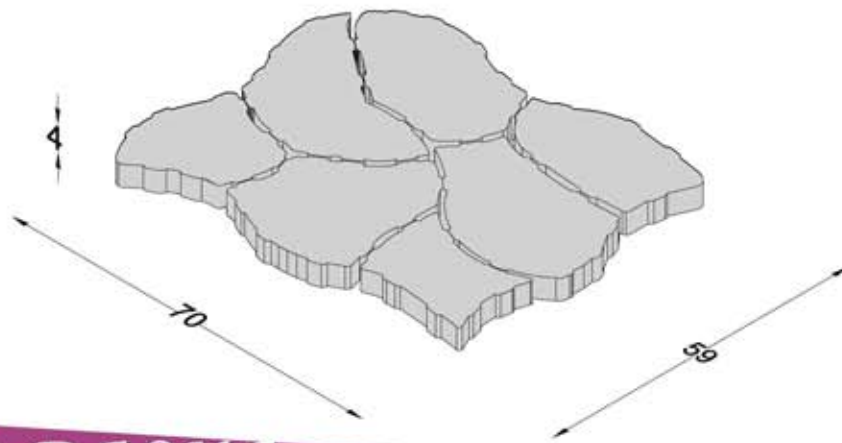

LIVENA DASKA

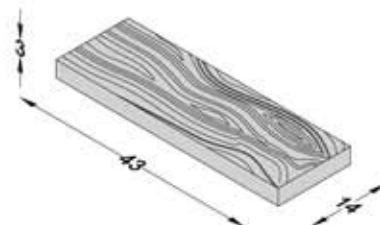



PERA 60

GABARIT: 70/120/230
TEŽINA: 450kg



ERA 90

GABARIT: 80/160/280
TEŽINA: 900kg



ERA 130

GABARIT: 100/180/270
TEŽINA: 1250kg



ERA 200

GABARIT: 240/95/300
TEŽINA: 2000kg



PERA 50

GABARIT: 110/60/210
TEŽINA: 600kg





KAMINI

Izrađujemo ugradne kamine različitih dimenzija i modela. Ložište kamina može biti otvoreno ili zaštićeno prozirnim termičkim staklom, tako da ložište postaje centralni deo kuće oko kojeg se okupljamo, uživajući u toplini vatre.

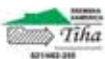

Više informacija: www.tiha-beton.rs

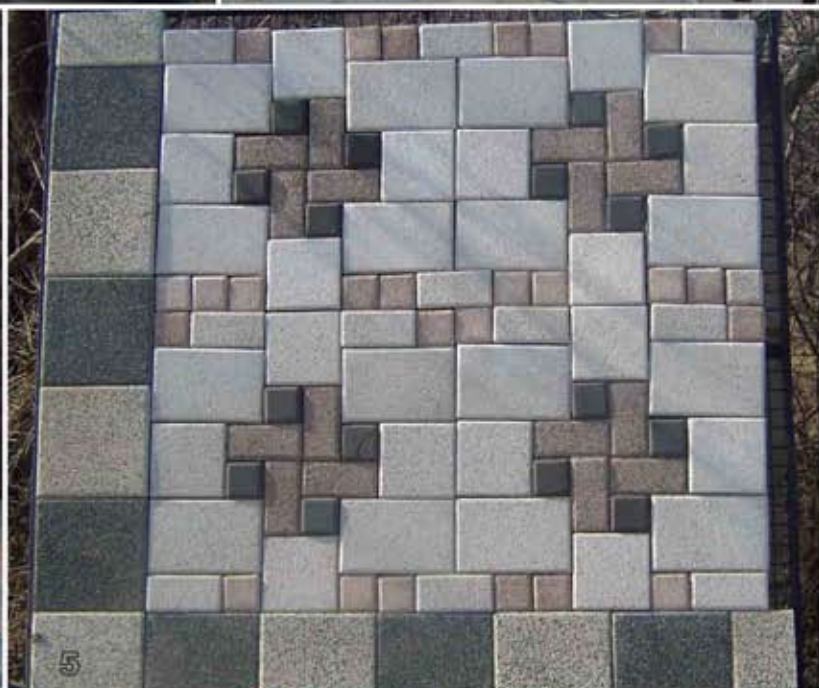

IZLOŽBENI PANOJI





DRVENE KUĆE





Model DK 1

NAJAM VEĆ OD 7,5 EUR/DAN

**DRVENE KUĆICE KONTEJNERI
IZNAJMLJIVANJE I PRODAJA**

Pogodne za transport

**Idealne za kancelarijske prostorije, za odmor,
sajamske manifestacije...**

**Moguće prilagođavanje i izrada po zahtevu
kupca**

Posebne pogodnosti za dugoročne zakupe



Info:

doo.tiha@gmail.com



Brza raspoloživost

NAJAM VEĆ OD 10 EUR/DAN

Model DK 2





OPREMA ZA GRADILIŠTA



TROFAZNI MOBILNI KOTAO
TMK 150



Koristi se na gradilištima, kada vremenski uslovi (hladnoća) ne dozvoljavaju kvalitetno spravljanje betona ili maltera. Trofazni mobilni kotao je gabaritnih dimenzija 480x480x1260mm i zapremine 150l. Unutrašnji kazan je obložen izolacijom debljine $d=30\text{mm}$. Kotao ima grejač snage 6kW. Maksimalna radna temperatura je 100°C . Ima ugrađen termometar sa čaurom, trostepeni termostast. Izolaciju unutrašnjeg kazana pokriva pocinkovani lim $d=0,5\text{mm}$. Ukupna težina praznog kotla je 55kg. Sa strane kotla su postavljene ručke koje omogućavaju lak prenos na gradilištu.

- snabdevanje vodom preko vodovodne mreže ili iz kante preko levka sa sitom
- korišćenje tople vode-odjednom 150l na željenoj temperaturi ili dodavanjem vode
- kotlovi su komplet pocinčani
- urađena kvalitetna zaštita od udara struje
- ne postoji opasnost od eksplozije



SKELE

Služe za bezbedno izvođenje radova koji se izvode na visini u krugu gradilišta. Širina skele je 0,86m a dužine su 1,5 i 3,0m. Izrađene su od pocinkovanih kutijastih profila, iz delova koji se brzo sklapaju na licu mesta p o m o ć u samoosiguravajućih šrafova. Točkovi su okretni sa kočnicom. Nosivost skele je 4 kN. Radna platforma je od drveta i može se premeštati po stranicama u zavisnosti koja nam je radna visina potrebna.

- skele proizvodimo po evropskim standardima



OPTEREĆENJE
NA SLICI
500 kg



**TRANSPORTNE
TRAKE/VAGE**

Transportne trake koje su ujedno i vage služe za efikasan prenos agregata od deponije agregata do otvora mešalice za beton. Sastoji se od postolja, nosača, pogonskog i zateznog valjka, gumene trake, neprekidne gumene trake i vage. Gabariti i nosivost se projektuju po zahtevu kupca od 200kg do 2t.



VIBRO STOLOVI

Proizvode se kao stolovi za vibriranje betona u kalupima i za vađenje gotovih elemenata iz kalupa. U zavisnosti koje elemente vibriramo, radimo stolove za ploče i ivičnjake. Vibrostolovi za ivičnjake imaju kraće noge zbog lakšeg uklanjanja kalupa posle vibriranja sa radne ploče stola. Na vibrostolove ugrađujemo vibromotore po zahtevu kupca za traženu težinu vibriranja. Kod vibrostolova za vađenje elemenata radna površina se sastoji iz zamenjivih ploča koje imaju otvore u obliku elemenata.



MEŠALICE

Mešalice na benzin

Jedinstveno u regionu

Mešalice za beton na benzinski pogon



Horizontalne mešalice

Horizontalne mešalice su namenjene za mešanje komponenti betona. U njima se postiže visok stepen homogenosti betonske smese. Konstrukcija je pouzdana i jednostavna za održavanje. Sastoje se iz postolja i kružne posude za mešanje. Lopatice za mešanje pokreće motor sa reduktorom. Inspekциони otvori na mešalici omogućavaju nadgledanje i čišćenje. Pražnjenje mešalice je na dnu posude za mešanje, ručnim otvaranjem zasuna, beton se prihvata građevinskim kolicima.

Kapacitet punjenja: velik za automatsko punjenje-oko 8m³/h; za manuelno punjenje zavisi od individualne organizacije ubacivanja cementa i vode.

Vreme mešanja: 30 sec



VIBRO PLOČE
VELIKI IZBOR VIBRO PLOČA
80-600kg
RENOMIRANIH SVETSKIH
PROIZVOĐAČA
BOMAG, WACKER,
AMMANN...



KOMPRESORI



HELIKOPTERI



VIBRO LETVE



MAŠINE ZA MALTERISANJE



VIBRO IGLE

Valjci, vibro ploče, vibro igle, vibro letve, vibro motori, helikopteri, mašine za rezanje betona, kalupi za probne kocke, mehanički sečko, tamperi, kompresori, mašine za mašinsko malterisanje...

Sva oprema za obradu betona i ugradnju prefabrikovanih betonskih elemenata za niskogradnju i visokogradnju.

office@tiha-beton.rs
www.tiha-beton.rs

tel/fax: +381 21 462 255
mob: +381 62 6000 64



PRODAJA POLOVNIH PRESA ZA PROIZVODNJU BETONSKE GALANTERIJE
PROJEKTOVANJE I SKLAPANJE KOMPLETNIH NOVIH SISTEMA
ZA PROIZVODNJU BETONSKE GALANTERIJE

KOMPLETAN KNOW HOW



Betonare od 0,5 do 4m³,
protivstrujne sa dve osovine.
Moguća kupovina komponenti,
polu-automatskih i automatskih.
30 m³/h betona...



Pokretne vibro prese
-Elemente izrađuje
na betonskoj pisti.
-Visoka produktivnost

Prese za proizvodnju betonske
galanterije, kao i kompletne linije.
Projektovanje, trgovina, montaža
kompletnih sistema. Izrada alata
za sve tipove mašina...

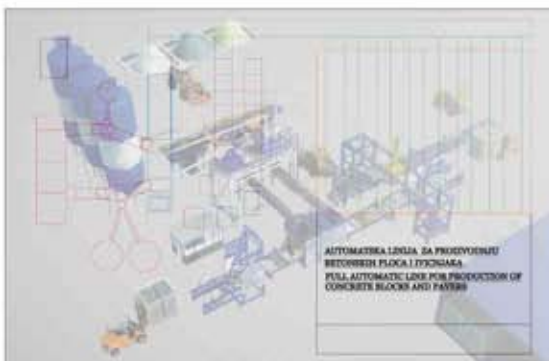

Kotlovi namenjeni za centralno grejanje individualnih domaćinstava, poslovno/industrijske i poljoprivredne pogone.

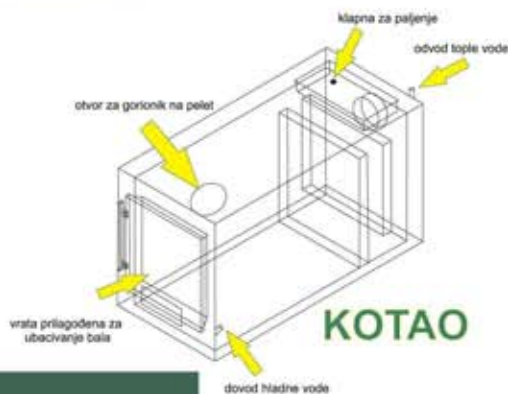
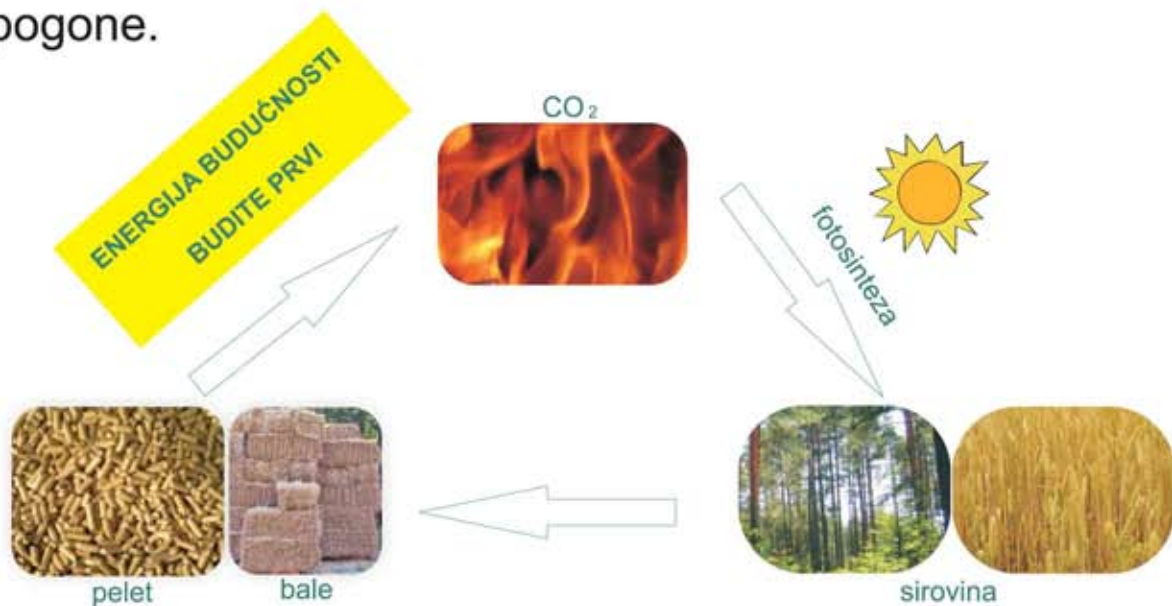

Kotao je namenjen za loženje biomasom (pelet, balirana slama soje i žita, kao i ostalim gorivnim otpacima).

Kotao se pravi od čeličnog lima i bešavnih cevi. Ložište se pravi od kotlovskog lima otpornog na uticaj visokih temperatura. Ispitivanje se vrši na pritisak od 5 bar. Kotao je obložen izolacijom od mineralne vune i oplatom od lima radi smanjenja gubitaka i povećanja efikasnosti u korišćenju energije.

office@tiha-beton.rs
www.tiha-beton.rs

tel/fax: +381 21 462 255
mob: +381 62 6000 64

Kapacitet kotla od 30-200 kW i veći
Preporučuje se sa izmenjivačem energije



*AUTO NASTREŠNICE SA BETONSKOM STOPOM
I METALNOM KONSTRUKCIJOM*

EKSKLUZIVNO

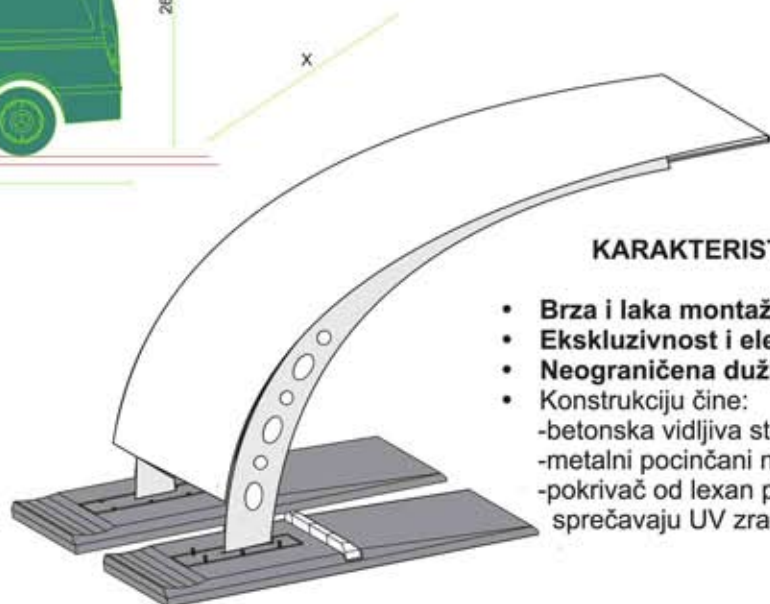
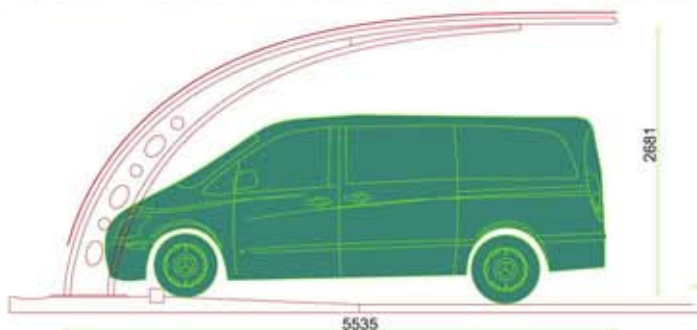

KARAKTERISTIKE:

- **Brza i laka montaža**
- **Ekskluzivnost i elegantnost**
- **Neograničena dužina**
- **Konstrukciju čine:**
 - betonska vidljiva stopa
 - metalni pocinčani nosači
 - pokrivač od lexan ploča koje sprečavaju UV zračenje

office@tiha-beton.rs
www.tiha-beton.rs

tel/fax: +381 21 462 255
mob: +381 62 6000 64

SEČENJE VODENIM MLAZOM WATER JET CUTTING

 e-mail: office@aquarez.rs
 web: www.aquarez.rs

Rešetke za
water jet
mašine

MLAZOM DO CILJA



Nudimo vam usluge sečenja:

- svih vrsta čelika: hladno valjani čelici, toplo valjani čelici, hardox, legurisanе čelike...
- inox, bakar, aluminijum, aluminijumska saća, mesing, titanijum...
- sve vrste keramika (keramičke pločice, izrada intarzija, listela, mozaika, isecanje raznih motiva, oblika, u vidu slobodne forme u arhitekturi i građevinarstvu, kao i skraćivanje pločica na meru)
- granit, mermer, beton,
- staklo (ogledalo), plesiglas, plastika, klirit, teadit, drvo, iverica, lesanit, meki sunđeri, karton,



SAMOUSLUŽNE AUTO PERIONICE

DELFIN WASH

SAMOUSLUŽNA AUTOPERIONICA



VEOMA BRZO, JEFTINO
I USPEŠNO PRANJE VAŠEG
AUTOMOBILA NA NOVO OTVORENOJ
SAMOUSLUŽNOJ AUTO PERIONICI
FIRME "DELFIN WASH"
NA UGLU ULICA
RUMENAČKE I INDUSTRIJSKE
(U KRUGU MERKURA)



potpuna
zaštita
od kiše

HIDROIZOLACIONA REŠENJA ZA ZAŠTITU POROZNIH POVRŠINA



TEHNIČKA PODRŠKA
0800 102 103

Od Ponedjeljka do Petka
8:00-16:00

ISOMAT D.O.O
GRAĐEVINSKA HEMIJA I MALTERI
www.isomat.co.rs
info@isomat.co.rs

PRHOVAČKA BB
22310 ŠIMANOVCI
Tel: +381 22 2150 100
Fax: +381 22 2150 101

isomat
building quality

UPIS 2012

Čekamo te u upisnom roku.

EDUCONS
UNIVERZITET

www.educons.edu.rs

BESKONAČNO
MNOGO
RAZLOGA

+ 381 21 489 36 10

Vojvode Putnika 87

21 208 Sremska Kamenica

www.educons.edu.rs

Educons Univerzitet Sremska Kamenica



twitter.com/ueducons



Zanima te zaštita životne sredine. Hoćeš da budeš nezavisan. Primećuješ marketing svuda oko sebe. Završio si srednju školu. Imaš talenat za slikarstvo. Zanima te turizam. Znaš šta znači održivi razvoj. Oduvek želiš da postaneš doktor nauka. Želiš da se oprobaš u naučnom radu. Čuješ da su finansije krvotok svakog posla. Misliš da bi bio dobar menadžer. Svi tvoji drugari upisuju Educons. Želiš da putuješ. Vidiš potencijal u industriji sporta. Zanimljiva ti je organska proizvodnja hrane. Veruješ da je znanje moć. Dugo već zelis spostveni mali biznis. Voleo bi da studiraš nešto zanimljivo.

* Beskonačno mnogo razloga da upišeš



DOO JOLIĆ CO KIKINDA

BAŠAIDSKI DRUM BB

KIKINDA

TELEFONI: 0230 442 003, 24 778

jolicdoo@gmail.com

www.trgovinajolic.net

Firma Jolić Co osnovana je 1996.godine u Kikindi kao porodična firma.

Trenutno firma raspolaže sa preko 1500 artikala, isključivo fokusiranih na grube građevinske radove salon keramike, proizvodnju fert gredica, krovne pokrivače, hidro i termoizolaciju, gipsarske proizvode, sanacije objekata...

Asortiman pokriva gradnju od temelja do završnih radova u objektu. Prodaja je bazirana na konsultativnoj prodaji. Radi se na usavršavanju prodavaca i najveća pažnja je fokusirana na odnosu prema kupcu. Jer najveći kapital firme Jolić Co su ZADOVOLJNI KUPCI.



GRAĐEVINSKI MATERIJAL OD TEMELJA DO KROVA



Noviteti sezonske rasade - tepih trave ekstra kvaliteta

Spoljno i unutrašnje korištenje dekorativnih ukrasnih saksija



CEO VRT NA JEDNOM MESTU

VRT dizajn



Korištenje vizuelnih efekata u ostvarivanju celokupnog ugodaja

Projektovanje jedinstvenih rešenja prema optimalnim potrebama klijenata

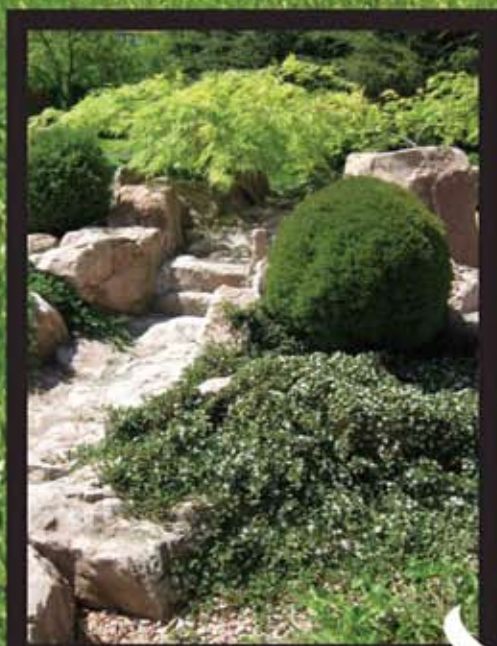

Formiranje vodenih biotopa - alpinetuma sa akcentom na dizajn ambijenta.

Vertikalna i krovna ozelenjavanja uz pratnju aktuelnih trendova



Planiranje i uređenje javnih površina uz neophodne licence



Kompletna izrada pratećih sadržaja - popločanja drenažni i zalivni sistemi, vrtne detalji i dr.



Ugradnja retkih i jedinstvenih vrste biljaka sa bogatim stručnim iskustvom i poštivanjem pravila struke



EUROMEDICINA

Kompletno medicinsko snabdevanje

- Bolnički i laboratorijski nameštaj
- Medicinska oprema
- Potrošni materijal
- Higijena i dezinfekcija
- Laboratorijski aparati i oprema
- Laboratorijski potrošni materijal

EUROMEDICINA
Laze Lazarevića 25
21000 Novi Sad

e-mail:
info@euromedicina.co.rs
web:
www.euromedicina.co.rs

Telefon:
+381 21 466-800
+381 21 468-185



E-mail: arion-doo@nadlamu.com



Tel/Fax: 021/824-700



TENISKI KLUB I ŠKOLA TENISA „PETLOV SALAŠ“

● Najpovoljnije iznajmljivanje teniskih terena svakim danom od 8.00-24.00

● Škola tenisa za decu i odrasle u sklopu koje postoji mogućnost individualnih i grupnih časova po najnovijim metodama rada i izuzetno pristupačnim cenama.

● Najkvalitetnija šljaka, po čemu smo poznati i u šta se možete uveriti.



Adresa:

Podunavska 2, početak puta za Kamenjar sa desne strane, ispred restorana „Ribarska noć“ u potpuno prirodnom ambijentu

Sve informacije i rezervacije na telefon:

062/17-89-88-4





НАЦИОНАЛНИ
ПАРК
Фрушка гора

КАТАЛОГ

рустик елемената



Шумска гарнитура
(храст)



Шумска клупа са
наслоном (храст)



Шумска гарнитура
(багрем)



Обавештајна табла са
кровом 1,4м



Надстрешница "печурка"



Надстрешница (12м2)



Надстрешница са
дуплим кровом (16м2)



Обавештајна табла са
кровом 2м



Жардињера округла
(багрем)



Жардињера "точак"
(багрем)



Љуљашка



Обавештајна табла са
кровом 2,8м



Клацкалица



Пешчаник



Пењалица



Коњић

ЈП "Национални парк Фрушка Гора"
Служба за комерцијалне послове
РЈ "Уређење простора"
Иришки пут 72, Парагово

Тел.: 021/462-711, 461-166
Факс: 021/462-662



UNIVEREXPORT
ONLINE



LAKOLIJJE
Univerexport e-hipermarket

RADNO VREME:
NON-STOP
7 DANA U
NEDELJI
www.elakolije.univerexport.rs

BESPLATNA
DOSTAVA
U PROMO
PERIODU
www.elakolije.univerexport.rs

MINIMALAN
IZNOS ZA
KUPOVINU JE
1500 RSD
www.elakolije.univerexport.rs

ODLOŽENO
PLAĆANJE DO
180 DANA
www.elakolije.univerexport.rs

eLAKOLIJJE je Univerexport online servis za naručivanje i dostavu robe koji će Vam omogućiti da Vaše vreme koristite na Vama ugodniji način

PREKO
12000
ARTIKALA U PONUDI
PO NAJPOVOLJNIJIM CENAMA
www.elakolije.univerexport.rs

Savremeni ritam života nameće novi i brži stil življenja i ne ostavlja nam previše vremena. eLAKOLIJJE je rešenje koje Vam nudi kompanija Univerexport. Sve što Vam je potrebno za domaćinstvo, svakodnevno možete poručiti, a u najkraćem roku, proizvodi će biti dostavljeni do vrata Vašeg doma, čak i ako Vam lift ne radi. 😊

Iskoristite mogućnost kupovine u najvećem online hipermarketu u Srbiji. Promotivni period rada, eLAKOLIJJE - Univerexport servisa za naručivanje i dostavu robe, počeo je od 1. aprila 2012. godine

Više informacija o eLAKOLIJJE servisu pronađite na adresi:



E-MAIL
elakolije@univerexport.rs

CALL CENTAR
0800/345678
PON-PET 7:30-15:30h



www.elakolije.univerexport.rs

IZLOŽBENI SALONI



**NOVI SAD-POGON I, CENTRALA
(SREMSKA KAMENICA)
Sonje Marinković 2a
tel/fax +381 21 462 255, 464 174;
mob. 062/6000-64**

**KIKINDA
STOVARIŠTE JOLIĆ
Bašaidski drum bb
0230/442-003**

**VETERNIK
ARION
Dragoslava Srejsovića 46
021/824-700**

**ZEMUN
DENTING
Mačvanska 12
011/31-63-404**

Tradicija, kvalitet, zanatsko umeće



Mi gradimo da traje...



PROIZVODNJA
BETONSKE GALANTERIJE
I
TRGOVINA
GRADEVINSKOM OPREOM

www.tiha-beton.rs
office@tiha-beton.rs
do.tiha@gmail.com

Pogon I
NOVI SAD
(SREMSKA KAMENICA)
Sonje Marinković 2a
Telefon: +381 21 464 174
Fax: +381 21 462 255
Mobilni: +381 62 6000 64

Pogon II
BEOGRAD
(PEĆINCI)
Školska 53
Fax: +381 21 462 255
Mobilni: +381 62 6000 64



Urednik:
Siniša Ograsović
Vladimir Štarković

Moguća su greška u papirni adresi.
Proveriti adresi su precizno i nula za bode
sadržavajući pravilno adresiranje.